

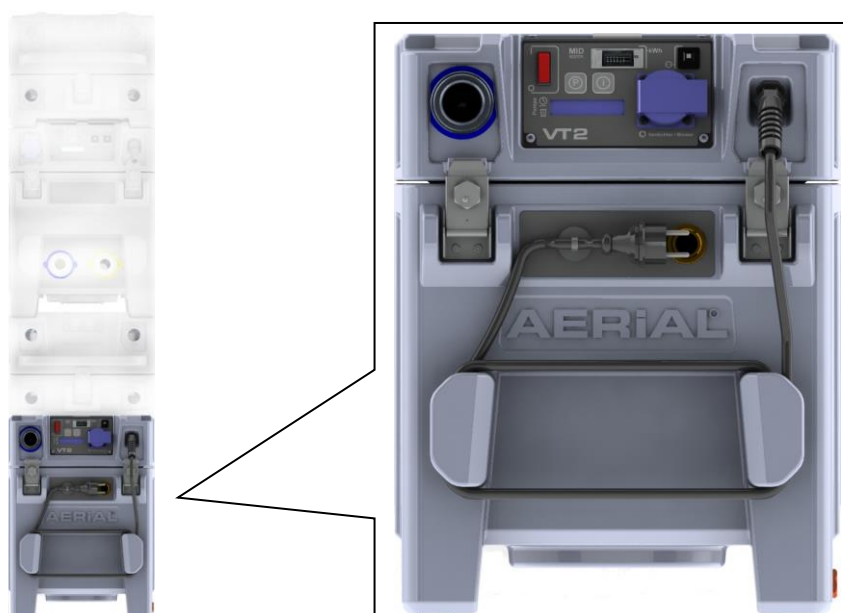

INSTRUCTION MANUAL

Water Separator

Series

VT2





This instruction manual shall not be reproduced, copied and distributed, neither in parts nor completely, without the manufacturer's written permit.

All rights reserved

The instruction manual is based on the technical and product-specific parameters. The manufacturer reserves the right to add supplementary information to the instruction manual.

Using a device outside the specified conditions and contrary to its designated use will lead to the forfeiture of all warranty claims.

As of: 09_2020



CONTENTS

| | | |
|-----------|---|-----------|
| 1 | Notes on this instruction manual | 2 |
| | Target groups | 2 |
| | Conventions | 2 |
| | Designated use | 3 |
| 2 | Safety | 3 |
| | Safety devices | 3 |
| | Hazards from accessories | 3 |
| | Authorised operator | 3 |
| | User | 4 |
| | Safety instructions | 4 |
| 3 | Construction | 5 |
| | Connections on the device rear side | 6 |
| | Drain plug on device rear side | 6 |
| 4 | Transport and installation | 7 |
| | Transport | 7 |
| | Scope of delivery | 7 |
| | Operating conditions | 7 |
| | Installation | 7 |
| 5 | Operation and operator control | 8 |
| | Operating elements | 8 |
| | Commissioning | 9 |
| | Operation | 10 |
| 6 | Maintenance and service | 10 |
| | Maintenance work | 10 |
| | Drain residual water | 11 |
| | Clean coarse filter | 11 |
| 7 | Troubleshooting | 12 |
| | Faults | 12 |
| 8 | Shutdown, storage and disposal | 13 |
| | Shutdown | 13 |
| | Storage | 13 |
| | Disposal | 13 |
| 9 | Specifications | 14 |
| 10 | Accessories | 14 |
| 11 | EU Declaration of Conformity | 15 |

NOTES ON THIS INSTRUCTION MANUAL

1 Notes on this instruction manual

This instruction manual is part of the product. It contains all important information on how to transport, install, operate, store and dispose of the device from **AERIAL** properly and safely. Therefore keep this instruction manual in a safe place.

Target groups

This instruction manual addresses the users and operators of the devices manufactured by **AERIAL**. They must have read and understood the instruction manual. The physical and psychological preconditions for proper and safety-conscious handling of the devices must always be guaranteed.

Conventions

Warnings

In this instruction manual you will find information intended to warn you of possible hazards at the beginning of a specific action.



DANGER

Type and source of hazard

This symbol in connection with the signal word "DANGER" refers to a life-threatening situation. Failure to observe this warning will result in serious, fatal injury.

- ➞ This arrow marks precise steps to avert danger which must always be performed.



WARNING

Type and source of hazard

This symbol in connection with the signal word "WARNING" refers to a dangerous situation. Failure to observe this warning can result in life-threatening injury and death.

- ➞ This arrow marks precise steps to avert danger which must be performed.



CAUTION

Type and source of hazard

This symbol in connection with the word "CAUTION" warns of minor or moderate injury and potential material damage.

- ➞ Measures to prevent personal injury or material damage are described here.



In this box you find tips and information concerning the use of the device.

Designated use

The water separator VT2 shall be used exclusively as a water suction device. The device is designed for vacuum operation. Please observe the permissible combinations (see chapter Operator Control, page 8 - 9).

The water separator VT2 is designed exclusively for use at atmospheric pressure. Operating the adsorption dryers within the limits of designated use also involves observing the specified operating conditions

(refer to page 7). Any use of the device going beyond the designated use specified above is considered contrary to its designated use.

Misuse is concerned if the water separator VT2 is used for purposes not included in designated use. In these cases the manufacturer does not assume any liability for personal and material damage.

2 Safety

Safety devices

The water separator VT2 was subjected to thorough safety testing. Improper operation or misuse will cause danger to

- the operator,
- the machine and other material property of the user,
- efficient operation of the machine.

All persons involved in the installation, commissioning, operation, maintenance and servicing of the devices must

- be properly qualified,
- closely observe the instructions set out in this manual.

Hazards from accessories

Air hoses, power cables and air filters must be properly installed, and must not disable the protection devices of the VT2. The operating elements must always be accessible.

Authorised operator

The water separator VT2 may only be operated by persons commissioned and instructed by the user. In the working area the operator is responsible to third parties. For all activities

SAFETY

on the device the responsibilities must be clearly defined and observed. Unclear competences are a safety risk.

User

The user must

- make the instruction manual accessible to the operator,
- make sure that the operator has read and understood the instruction manual.

Safety instructions

The devices must **not** be used under the following conditions:

- in rooms with potentially explosive atmospheres.
- in rooms with aggressive atmospheres, e.g. ammonia.
- in rooms with water with a pH value outside the range from 4 to 9.
- In rooms with salt or liquids with a salt content > 1%.
- in rooms with high solvent concentration.
- in rooms with extreme dust load.

In addition the following must be observed when using the water separator VT2:

- Work on electrical equipment may only be carried out by skilled electricians.
- Original spare parts or spare parts approved by the manufacturer shall exclusively be used.

3 Construction

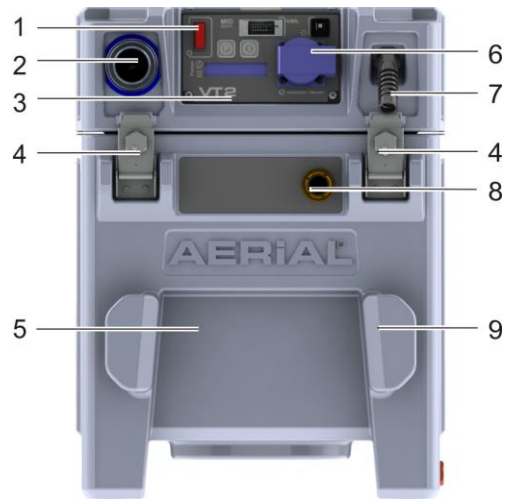

Fig. 1: AERIAL water separator series VT2 - overview

| | | | |
|---|--------------------------------------|---|--|
| 1 | On / Off switch | 6 | Appliance socket for compressor |
| 2 | Connection for compressor | 7 | Power cable |
| 3 | Control panel with full text display | 8 | G $\frac{3}{4}$ " threaded connector for waste water |
| 4 | Tension lock | 9 | Holder for power cable |
| 5 | Water container and pump | | |

Water separator VT2 ready for connection designed for screed insulation layer drying in the vacuum mode, with compressor or soundbox VP2/VP3/VP6.

The connected compressor (soundbox VP2/VP3/VP6) draws the air/water taken in (e.g. from the insulation layer) through the water separator. The water is collected in the bottom part of the VT2. The integrated level controller switches the side channel compressor off and the waste water pump on. The waste water pump pumps the water out of the VT2 through the waste water hose.

When the water level in the VT2 drops below approx. 1 cm, the compressor switches on again and operates up to the next pumping process.

CONSTRUCTION



Use tubes of 50 mm diameter for efficient drying. Smaller tubes result in high energy consumption and longer drying times.

Connections on the device rear side

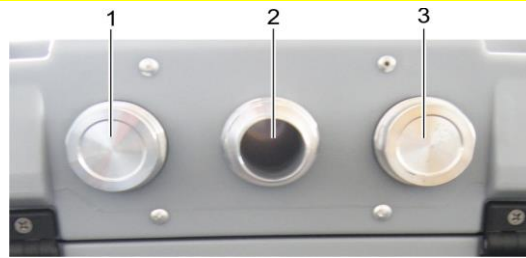

Fig. 2: AERIAL water separator VT2 rear side

| | | | |
|---|--|---|-----------|
| 1 | Screw cap | 3 | Screw cap |
| 2 | Connection pipe Ø38 mm / Ø50 mm or Ø50 pipe | | |

Three intake pipes are arranged on the device rear side. The intake holes not used can be closed by screw caps. Screw caps are included in the scope of delivery.

Drain plug on device rear side



Fig. 3: AERIAL water separator VT2 rear side

| | | | |
|---|-------------------------------|--|--|
| 1 | Drain plug for residual water | | |
|---|-------------------------------|--|--|

The device foot is provided with a drain plug. To discharge residual water the drain plug can be turned out.

4 Transport and installation

Transport

1. Remove the packaging material completely and dispose of according to the local regulations.
2. Check the delivery for completeness.
3. Use the lateral handles or the handle in the middle of the cover to transport the water separator to the place of installation.

Scope of delivery

- Water separator VT2, accessories (see chapter 10, page 14)
- One instruction manual

Operating conditions

The water separator VT2 is designated for vacuum drying and screed insulation layer drying in the vacuum mode. It works without problems in the temperature range from 0 °C to 35 °C.



Installation

The devices can be stacked, and are provided with fixing points for a belt system on the right and left.

Fig. 4: Fixing points for belt system

Connection



DANGER

Danger to life due to electric shock

- ⇒ Prior to commissioning the technical data of the water separator VT2 must be compared with the conditions prevailing in the room of installation!

The following items must be checked prior to electrical connection of the water separator:

- Is the mains voltage in conformity with the voltage of the device?
- Are socket and supply system sufficiently fused?
- RCCB required!
- Connect the power plug of the water separator to a suitable power outlet.

OPERATION AND OPERATOR CONTROL

5 Operation and operator control



CAUTION

Danger of injury and damage to appliance

Inadmissible ambient conditions and improper operation of the device may constitute a risk.

- ➔ Read the instruction manual before commissioning the water separator VT2.

Operating elements

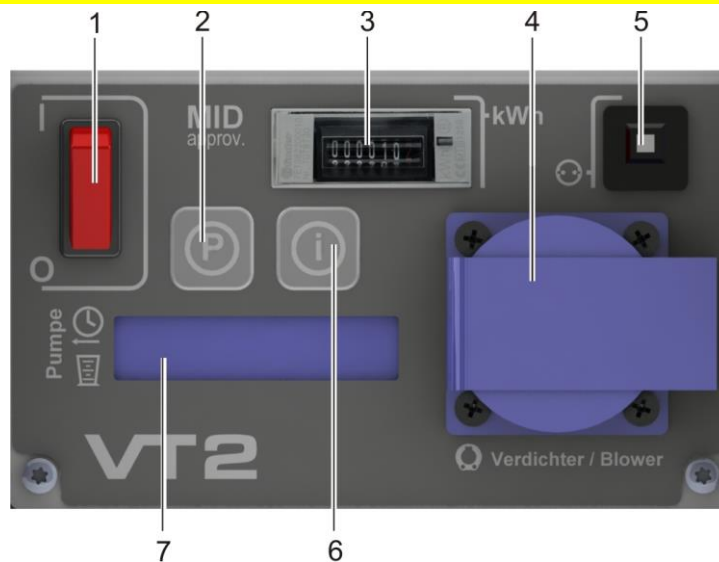



Fig. 5: Water separator VT2 control panel

| | | | |
|---|------------------|---|----------------------------|
| 1 | On / Off switch | 5 | Appliance socket fuse 16 A |
| 2 | Membrane key "P" | 6 | Membrane key "Info" |
| 3 | Watt meter (MID) | 7 | Display LED matrix, blue |
| 4 | Appliance socket | | |



The energy consumption of the compressor connected to the appliance socket (item 4) is not counted by the calibrated watt meter (MID) (item 7).

Membrane key "Info"

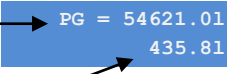
Duration 5 seconds

| | | | |
|---|----------|--|--|
|  | Press 1x | Total delivery volume of the pump (value not erasable) |  |
| | | Delivery volume since last switching-on of device | |

Membrane key "P"

| | | | |
|---|-------|---|--|
|  | Press | Pump switches on and runs as long as the key is kept pressed, indicator flashes |  |
|---|-------|---|--|

Commissioning

To commission the air water separator VT2 proceed as follows:

1. Connect the water separator VT2 electrically, s. page 7.
2. Ensure that the waste water hose has been connected to the threaded connector for waste water.
3. Ensure that the air tube has been connected to the connector for the compressor (s. page 5, Fig. 1, item 2) and to the air intake pipe on the compressor.
4. Ensure that the compressor (soundbox VP2/VP3/VP6) has been connected to the appliance socket of the water separator VT2.
5. Switch on the water separator VT2 via the "On / Off" switch (s. page 5, Fig. 1, item 1). The following indication appears in the display:

| | |
|-------------------------------------|-----------|
| Software version | VT2 V 2.0 |
| Serial number of electronics system | SN 123456 |

After booting the following indication appears in the display:

| | |
|-----------------------------|---------|
| Time in h | 00:00 h |
| Pump cycle volume in liters | 0 l |

MAINTENANCE AND SERVICE

Operation

The water separator operates as follows:

- At the moment when the water separator is switched on the compressor (soundbox VP2/VP3/VP6) connected to the appliance socket of the water separator starts running.
- The separated water is collected in the water container.
- When the water container is full, the appliance socket for the compressor (soundbox VP2/VP3/VP6) is disconnected.
- The pump is switched on and pumps the water out.
- When the water container is empty, the pump switches off.
- The compressor (soundbox VP2/VP3/VP6) switches on again.

6 Maintenance and service

Maintenance work



WARNING

Danger of injury by electric shock and risk of material damage

- ⇒ Always observe the general safety instructions when performing any maintenance and service work!



CAUTION

Damage to the device

Cleaning agents can cause damage to surfaces.

- ⇒ Use only mild detergents.

The cleaning intervals depend largely on the operating conditions. Therefore check your water separator after every use.

In order to guarantee trouble-free functioning of the device it must be regularly cleaned. Proceed as follows:

- Clean casing on the outside with a moist cloth.
- Drain any residual water before longer periods without operation.
- Clean coarse filter

Screw out all threaded connectors and threaded caps after each use and clean the threads. We recommend you to screw in only greased threaded connectors and threaded caps .

Drain residual water



Fig. 6: AERIAL water separator VT2, drain plug for residual water

| | | | |
|---|-------------------------------|--|--|
| 1 | Drain plug for residual water | | |
|---|-------------------------------|--|--|

- In case of longer periods without operation the residual water in the device must be discharged. To do so turn out the drain plug (s. fig. 6, item 1). Tilt and move the housing to and fro so that the residual water can flow out.

Clean coarse filter

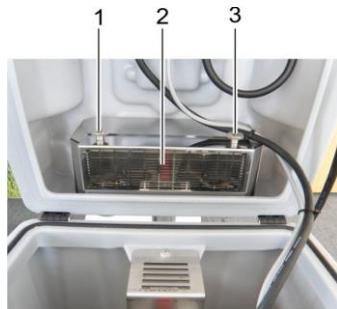

Fig. 7: Filter box with filter grille

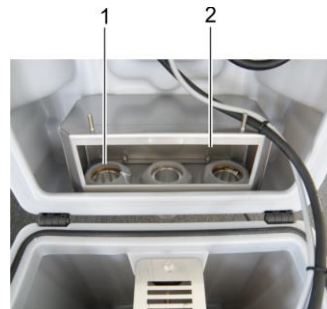

Fig. 8: Filter grille removed

| | | | |
|------|---------------|---|-------------------|
| 1, 3 | Knurled nuts | 1 | Intake openings |
| 2 | Filter grille | 2 | Filter box inside |

- Release tension locks (s. Fig. 1, item 4) and open cover.
- Release knurled nuts; remove and clean filter grille.
- Remove fluff, insulation material particles and fibres from the inside of the box.
- Insert filter grille, tighten knurled nuts, close cover, tighten tension locks.

TROUBLESHOOTING

7 Troubleshooting

If problems arise with the water separator VT2 please check the following points. Should the fault not be located please contact your technical advisor.



WARNING

Danger of injury by electric shock and risk of material damage

- The device may only be repaired by trained specialised staff. Within the warranty period, any work on the device shall only be carried out by the manufacturer or persons commissioned by him.
- Any work carried out by unauthorised persons shall lead to the forfeiture of all warranty claims!

Faults

| Problem | Possible cause | Remedy |
|--|--|---|
| Compressor (soundbox VP2/VP3/VP6) does not start running or has automatically switched off | Power plug not plugged into VT2 socket outlet | Plug in power plug |
| | Socket outlet fuse has tripped | Check the drying construction! Maximum current consumption at appliance socket: 16 A! |
| | Circuit breaker (of connected soundbox) tripped | Let the soundbox cool down and check the installation. |
| Compressor (soundbox VP2/VP3/VP6) draws in water | Connected soundbox defective | Arrange for repair by expert staff |
| | Compressor is not connected to the appliance socket of the VT2, but to permanent voltage | Connect compressor to VT2 appliance socket |
| "Pump Fault" appears in the display | Waste water hose too long or too thin | Shorten waste water hose |
| | Pump soiled | Clean pump |

8 Shutdown, storage and disposal

Shutdown

If you do not need the water separator VT2 for a longer period of time you can shut it down for some time. To do so proceed as follows:

1. Switch off the water separator VT2 via the On / Off switch (s. page 5, Fig. 1, item 6).
2. Pull the power plug.
3. Drain the residual water (s. fig. 6)

Storage

Store the sound water separator VT2 in conformity with the specified safety instructions (see page 4).

Disposal

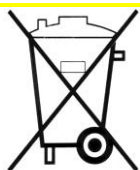

Please do not dispose of this device with the domestic waste.
Dispose of the device in accordance with the legal regulations.

SPECIFICATIONS

9 Specifications

| General data | | |
|----------------------|------------------------------|--|
| Power supply | 230 V/50 Hz | |
| Protection class | IP 22 | |
| Fusing | RCCB to be installed by user | |
| Operating conditions | 0 °C to + 35 °C | |

| Type | Unit | VT2 |
|---------------------------|-------------------|-----------------|
| Pump delivery volume | m ³ /h | 7 |
| Pump delivery height | m | 5 |
| Power consumption of pump | watt | 260 |
| Dimensions H x W x D | mm | 507 / 390 / 490 |
| Weight | kg | 18 |
| Power cable length | m | 4.5 |

10 Accessories

- Screw cap, 2 pieces
- Connection pipe 38/50 mm or Ø50 pipe, 4 pieces
- Gasket, 6 pieces
- Pipe marked blue (intake side marking), 1 piece

11 EU Declaration of Conformity

EU Declaration of Conformity according to EC machinery directive 2006/42/EC, Annex II, 1.A

Machinery directive 2006/42/EC
EMC directive 2014/30/EU
Low voltage directive 2014/35/EU

Manufacturer: AERIAL GmbH - Systeme zur Luftbehandlung
Oststraße 148, D-22844 Norderstedt

Product description: Water separator VT2

The product described is a water separator ready for connection.

| | | |
|-----------------------|---|-------------------------------------|
| Applicable standards: | EN ISO 12100 | Safety of Machinery |
| | EN 55 014-1:2006 + A1 : 2009 + A2 : 2011 | Electromagnetic Compatibility (EMC) |
| | EN 61 000-3-2:2014 | |
| | EN 61 000-3-3:2013 | |

This declaration of conformity shall become void if any modification not agreed with the manufacturer is made to the device.

Norderstedt on 26.09.2020



General Manager

**Dantherm GmbH
Oststraße 148
D-22844 Norderstedt**





CE

Dealer stamp:



AERIAL[®]
THE DRYING EXPERTS

AERIAL GmbH ■ Systeme zur Luftbehandlung
Oststrasse 148 · D-22844 Norderstedt
Phone 0049 (0) 40 526 879 0 · Telefax 526 879 20
E-Mail: info@aerial.de · Internet: www.aerial.de

